

EQUIPMENT / TOOLS REQUIRED

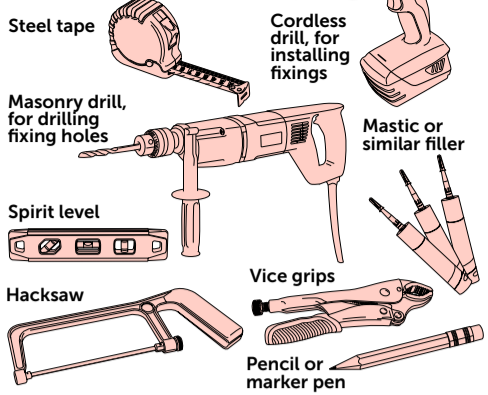

PRE-INSTALLATION CHECKS

- Check the package content is not damaged.
- The door frame supplied fits into the opening.
- The area is cleared of all obstructions.
- Package is complete (Check contents against the delivery note).
- Check it is safe to drill around the opening (electrical cables, gas pipes etc).
- The work area should be free from debris and the operator should beware of obstructions.
- All necessary tools in place.
- The tools are fully functional and there are no signs of damage.
- All door hardware is in place.

TROUBLESHOOTING

Problem	Possible fix
Door hitting on strike jamb or adjacent door if double	Refer to Door Frame Installation Advice.
Door leaning down away from hinge	Check that the jamb is straight and adjuster screws in the middle are not overtightened.
Door not touching top or bottom of strike jamb	Adjust strike or hinge jamb.
Double Door Set appears twisted when meeting in the middle	Adjust hinge jambs.
Door (when operating) is catching the threshold	Use hinge packers as required (3 supplied in a single door set and 6 in a double) See fixing kit.
P seal comes off when operating door	Refer to page 19 - 22
Exit hardware latch not locating	Check latch keep plate is installed.
Exit hardware not locking	Check shoot bolt adjustment.
Exit hardware double door set latch plate missing	The same latch is used for a single / double door-set. On a double door-set the latch plate overhangs the edge of the inactive leaf.
Keys missing	Keys on a single door are cable tied to a frame jamb, double door set they are in the installation box.
Gap between threshold and bottom of door leaf	Check that the threshold is supported along its length.
Cylinder not operating correctly	Loosen securing screw in face plate of lock, insert key and slowly operate the cylinder. Once operating correctly tighten securing screw.
Personnel door not latching correctly	File latch keep.

GETTING STARTED

ADVICE - Please check structural opening and door size are correct prior to beginning any work.

IMPORTANT - Transport damage or any other queries regarding the door set must be reported prior to installation.

The single door package is supplied assembled, this includes the threshold being fitted to the frame and the door being hinged.

Only the side expanders come separated. The double door package however comes completely disassembled. Before mounting the single frame, remove the door. Do not try to fit the frame with door hinged as you may damage the components.

ADVICE - Before laying the components down on the ground, protect them against damages and scratches.

FITTING THE THRESHOLD

Thresholds are installed on single door sets prior to delivery, only double door sets require thresholds to be installed on site.

Thresholds must be fitted directly to the frame before the frame installation.

Lay down the frame on the flat surface.

Make sure the threshold is the same size as the width of the frame (measure from outer edges).

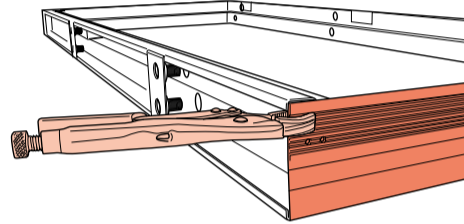

With help of vice grips hold the threshold on both sides to the bottom of the frame.

Once the threshold is perfectly aligned, fix the threshold to the base of the frame using the self drilling screws provided.

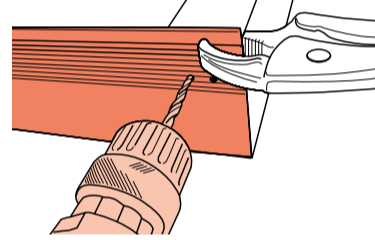

DOOR FRAME INSTALLATION

ADVICE - It is recommended, that at least 2 people fit the frame.

Before fitting the frame make sure you have everything necessary and you are well prepared to make your work faultless. The door set comes with fully adjustable expander sides. These take up the distance between the structure and the door frame ensuring a perfect fit with the minimal use of sealant, even if the structure is uneven. Each expander side can take up to 22mm on each side. The expander side fits over the side jamb (as shown in the picture) and it moves towards the structure when using the adjuster screws fitted in the frame.

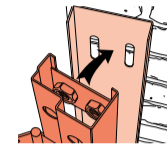

Before inserting the frame into the opening make sure your frame and adjustable expander sides are aligned.

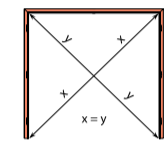

When you are ready, insert the frame into the opening. Make sure, the frame is perfectly square. You can check it is square by measuring from corner to corner using, for example, a steel tape (measurements should be identical). Ensure finished ground level allows for full operation of the door set, adjust the expander frame as required.

In order to check the frame sits straight and in the vertical position, place a spirit level parallel to the frame.

Once the frame is sitting in the opening and is

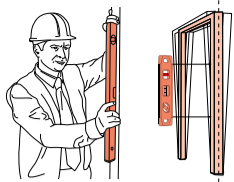

perfectly square, start screwing the adjusters through the frame holes, so that the frame is secure in the opening. The adjuster screws are turned using the hex bar supplied in the fixing kit. When screwing the adjusters clockwise, the expander side will move

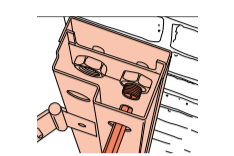

towards the structure. Start fixing on hinge side with one of the top fixing position. Fix through the adjuster screws with the correct fixing then check the frame alignment one more time with the spirit level. Fasten this fixing securely, then repeat using one of the lower fixing positions. Once these are secured check the full door operation. This should include strike side and meeting between double door set is correct.

Once in final position, drill through the remaining frame adjuster screws. When drilling pay attention not to damage the adjuster screws. Finally tighten the fixings.

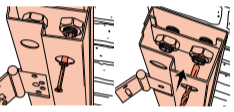

ADVICE - To avoid bowing the frame do not screw in the adjusting screws too far.

FIXING KIT

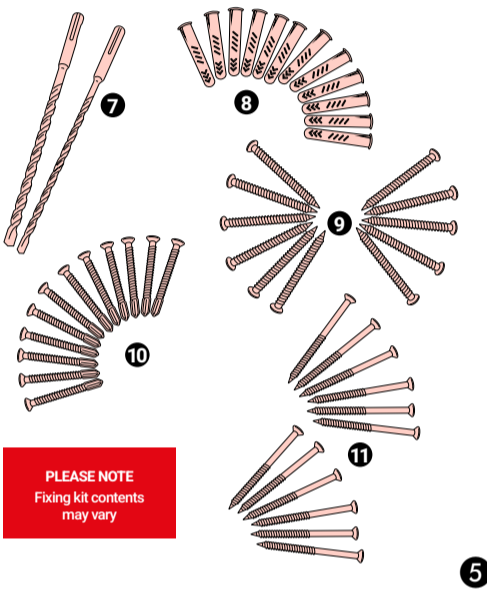
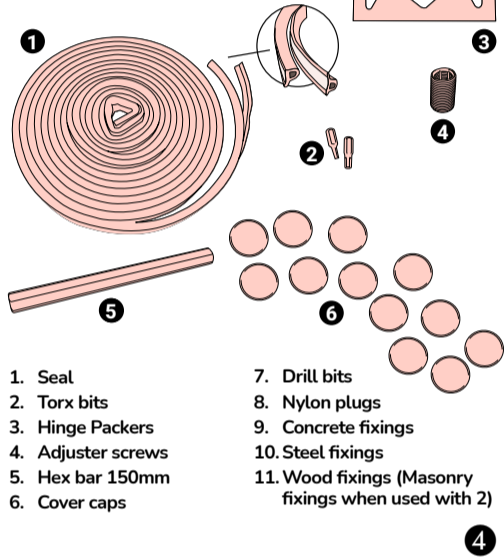

PLEASE NOTE
Fixing kit contents may vary

DEFINITIONS OF SAFETY GUIDELINES

Please read the manual and pay attention to the following symbols:

NOTE
General notification



WARNING - Potentially hazardous situation. If not avoided, could result in serious injury.

ADVICE
Manufacturers advice

IMPORTANT
Pay attention to details

DANGER - Do not expose power tools to rain or snow and do not use in damp or wet areas or where there is a risk of fire or explosion.



Use personal protective equipment. Always wear eye protection. Protective equipment such as mask, gloves, non-slip safety shoes, hard hat, or hearing protection used in appropriate conditions will reduce personal injuries.

Do not wear loose clothing or jewellery. Keep your hair, clothing and gloves away from moving parts of tools. Tie back long hair.

Stay alert. Watch what you are doing and use common sense when fitting the door. Never fit the door while you are tired or under the influence of drugs, alcohol or medication. A moment of inattention may result in serious personal injury.

Keep work area clean and well lit. Cluttered and dark areas invite accidents.

When drilling, do not over reach. Keep proper footing and balance at all times. This enables better control of the power tool in unexpected situations.

Do not operate power tools when they are dirty or wet. Dust or dampness on the surface of the tool make it more difficult to hold and, under unfavourable conditions, may lead to electric shocks.

Make sure you know how to switch power tools OFF before you switch them ON, in case you get into difficulty. Inspect each power tool before using it. If it shows any signs of damage, do not use it.

Always switch off and unplug power tools before attempting to service or adjust them.

For advice on the safety and suitability of power tools mentioned in this document refer to manufacturers' manuals.

VIDEOS AND OPERATING GUIDES

Visit our website to view installation videos and operating instructions.



Operating and Maintenance Instructions - Scan the QR code here.



Single Door Fitting Video - Scan the QR code here.



Double Door Fitting Video - Scan the QR code here.



Touching Up Paint - Scan the QR code here.



Visit our website to view installation videos for further guidance - Scan the QR code here.

OTHER DEFINITIONS

The term "power tool" in this manual refers to your mains-operated (corded) power tool or battery-operated (cordless) power tool.

GENERAL SAFETY

For advice on the safety and suitability of this product contact the manufacturer.

Never fit the door-sets until you have fully read and understood instructions laid down in this guide and the work place has been properly set up using the information it contains.



WARNING - There is a serious risk of personal injury if you do not follow all instructions.

Fitting these products should be done by a competent person who has read and understood these instructions. Anyone with either a temporary or permanent disability, should seek expert advice before commencing work.

Keep children, animals and bystanders away from the work area.

When using power tools do not operate them in explosive atmospheres, such as in the presence of flammable liquids, gases or dust. Power tools create sparks which may ignite the dust or fumes.

Power tools may be used only in a dry environment.

IMPORTANT INFORMATION

Visit our website to view installation videos and operating instructions.



It is essential that these instructions are read and understood by all the people participating in fitting the unit.

Make sure you are familiar with operating all the required tools mentioned in this manual. For more information about proper usage of the tools, refer to manufacturer's user guide.

It is recommended to keep operating instructions together with power tools.



INSTALLATION & MAINTENANCE INSTRUCTIONS

FOR SINGLE AND DOUBLE DOOR-SETS

It is very important that this sheet be given to and retained by the end user as it contains information that affects the warranty

Contents

Definitions of safety guidelines	02
General safety	02— 03
Equipment / tools required	04
Fixing kit	04— 05
Pre-installation checks	04
Troubleshooting	05
Getting started	06
Fitting the threshold	06
Door frame installation	07
Filing the lock keep	08
Fitting door to the frame	08
Fitting door hardware	08— 11
Panic hardware	10
Personnel door	11
Touching up the paintwork	12
Applying the seal	12— 13
Door seal installation	13
Operation and maintenance	13— 14
Warranties	15
Videos and operating guides	16

Any problems?

We are here to help.

Call us - 01524 727000
www.strongdor.com

FILING THE LOCK KEEP

If the door is a personnel door-set, the latch keep will require the radius filing, once the latch keep is working correctly install the paint protector.

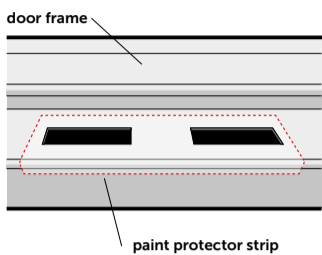
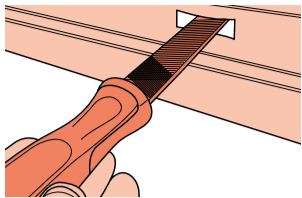

WARNING - There is a serious risk of personal injury if you do not follow all instructions.

FITTING DOOR TO THE FRAME



ADVICE - Fitting the door to the frame requires at least two people.

Once the frame is square and level, check that the door fits the frame. The door should have the hinges already fitted, but if not fit them.

Now hold the door up to the frame - at right angles to the frame (as if it's opened). Make sure the door is at the right height. At this stage using one fixing fit the top hinge to the frame first and then the bottom hinge.

Check operation of the door leaf.

Adjust the adjusting screws in the frame as required. When all the adjustments have been made secure the opposite side.

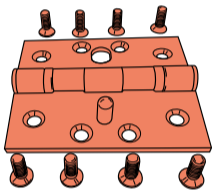

8

TOUCHING UP THE PAINTWORK

Strongdor supply a paint touch up system as part of the standard fixing kit. You can use it to cover paintwork scratches and chips, or for sealing the edges of a trimmed side expander frame. The powder supplied is an exact colour match to the door.



1. Remove the small powder coating pot from the top of the touch up stick.

2. Open it and combine the powder with the colourless base coat



3. Shake well.

4. Apply as required.

APPLYING THE SEAL

Using masking tape to protect the door-frame and brickwork, use mastic to seal round the edges of the door frame to make a water tight bond with the surrounding surface.

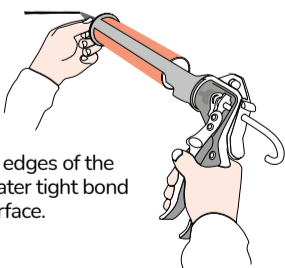

NOTE - For Secured by Design installations - the joints between the head jamb and the side jambs must be sealed with a suitable, weatherproof silicone sealant.

12



IMPORTANT - When installing a double door set always check that the door leaves meet in the middle, ensure all gap tolerances are parallel and door leaves operate correctly.

When everything is fitted, the door can be mounted. As explained, mount the door from the top hinge to the bottom. Use complete set of fixings.

FITTING DOOR HARDWARE

ARM CLOSURE

When the door sits firmly in the frame you can start fitting the closer arm.

Attach arm to spindle with screw. Using a wrench on the square shaft on bottom of closer, rotate shaft approx. 45° toward hinge edge of door.

Hold and place main arm on shaft on top of closer. Tighten arm screw with lock-washer securely.

When body is ready you can attach it to the door. Position body with arm attached over drilled holes on the door. Once fixed slide the latch.

The last step is to connect main arm to the frame arm. Make sure you tighten it securely. At the end fitting replace the cap at the bottom of the closer and replace the cover on the body.

For best practice please follow the manufacturer's manual.

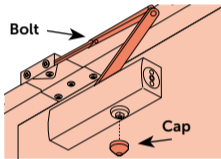
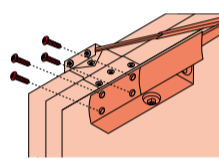

9

DOOR SEAL INSTALLATION

For all frame types installation of the seals must be installed in the following directions:

P SEAL

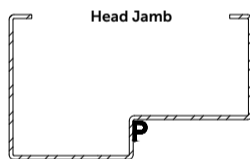

STRIKE JAMB

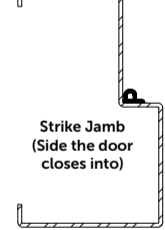

HINGE JAMB



TEAR DROP SEAL

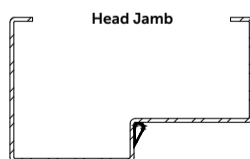

STRIKE JAMB

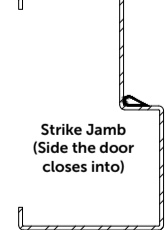

HINGE JAMB



ADVICE - Doors that are used up to 40 times a day are serviced at 2 monthly intervals. Doors that are used more than 40 times a day should be checked every 2 weeks.

13

PANIC HARDWARE

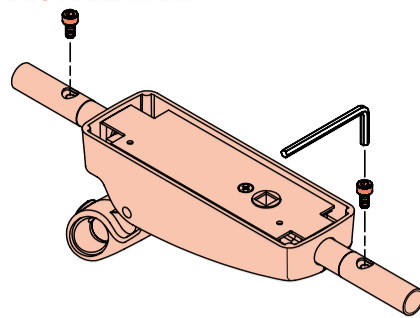

ADVICE - For security purposes the socket cap screws must be inserted from rear face.

PANIC HARDWARE LATCHES

Prepare head and threshold for respective keepers.

Ensure that back edges of top and bottom keepers are in line with rebate stop.

Pull door into closed position and ensure:

- that top tripper releases against keeper plate.
- that both shoots throw fully and enter their respective keepers correctly.

Depress push bar lever or push pad and ensure:

- that both shoots withdraw fully from their keepers.
- that top tripper engages and retains shoots in withdrawn condition.
- that shoots do not foul floor or head. Re-adjust if necessary.
- Threshold requires drilling for bottom keep location.

Fit end box on hanging stile of door ensuring that it is vertical and level with bolt box. Keep approximately 10mm distance from the frame.

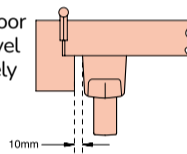

10

OPERATION AND MAINTENANCE

TO OPEN

Insert key (where applicable) and turn the key to retract the latch. Then retract the lever handles. Push bar or plate on exit hardware to release latch or bolt or any other hardware fitted to the door.

TO CLOSE

The door will close by either pulling the pull handle - retracting the lever handle or operating the panic furniture. The door leaf will latch into the receiving fixtures in the door-frame. Only use the hardware fitted to the door-set to open or close the door.



ADVICE - Encourage personnel to report any damage noticed during day-to-day usage, however minor it may seem, a prompt repair action can greatly prolong the useful life of the door.

Ensure the opening is free of obstruction at all times before closing the door. Do not leave external doors open in windy conditions.

MAINTENANCE INFORMATION

Maintenance periods should be determined according to operating sensitivity and local conditions to which the door is exposed.

Items to be checked during service (where applicable):

- Hinges,
- Latch operation,
- Lever handles,
- Pull handles,
- Thresholds and door seals,
- Furniture fitted onto door.

In common with all mechanical equipment these doors require regular maintenance to guarantee trouble free operation and avoid costly repairs due to damage.

MAINTENANCE INFORMATION

Before carrying out any cleaning or maintenance work any electrical supply must be switched off. Doors should be kept clean and free from accumulating dirt. This should be done using warm water with a mild cleaning detergent. Clean cloths should be used at all times to avoid scratching to the painted finish. Do not use any chemical solvents, bleach as they may affect the finish.

14



ADVICE - Where applicable, the "Push to Open" sign should be applied on the inside face of the door immediately above the operating element.



IMPORTANT - The exit hardware may vary. For the best installation practice please use manufacturer's manual.

PERSONNEL DOOR LOCK INSTALLATION

Check the handing of the lock is in right position. To change it (if required) release the latch head from the for-end by pushing up on the latch snib.

Then rotate the latch head to the desired position. Once rotated, push the latch head back into the for-end profile.

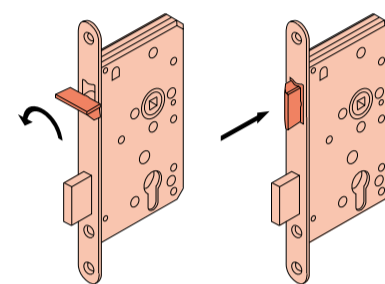
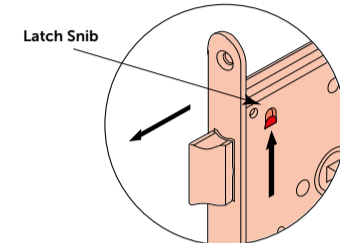

IMPORTANT - There is no need to open the lock-case. Lock type may vary.

11

WARRANTIES

The doors are guaranteed for 1 year under normal conditions of use and all hardware will come with manufacturers standard warranty. Free issue hardware is excluded from all warranties.

RE-ORDER INFORMATION

In the case of any faults or replacement parts required please contact the supplier. No spare parts are required to be carried by the customer.



IMPORTANT - Failure to comply with the manual will void all warranties any damage to the door-set will void all warranties

15